

Control

EBC22

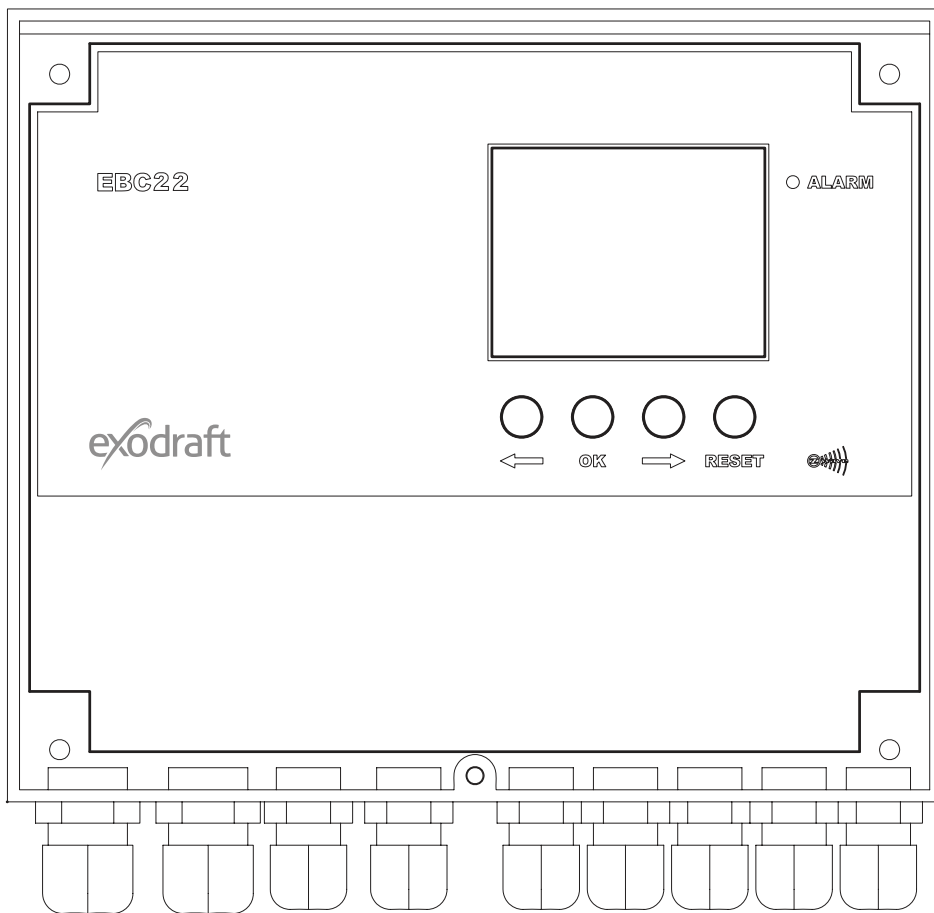

UK | Read and save these instructions!

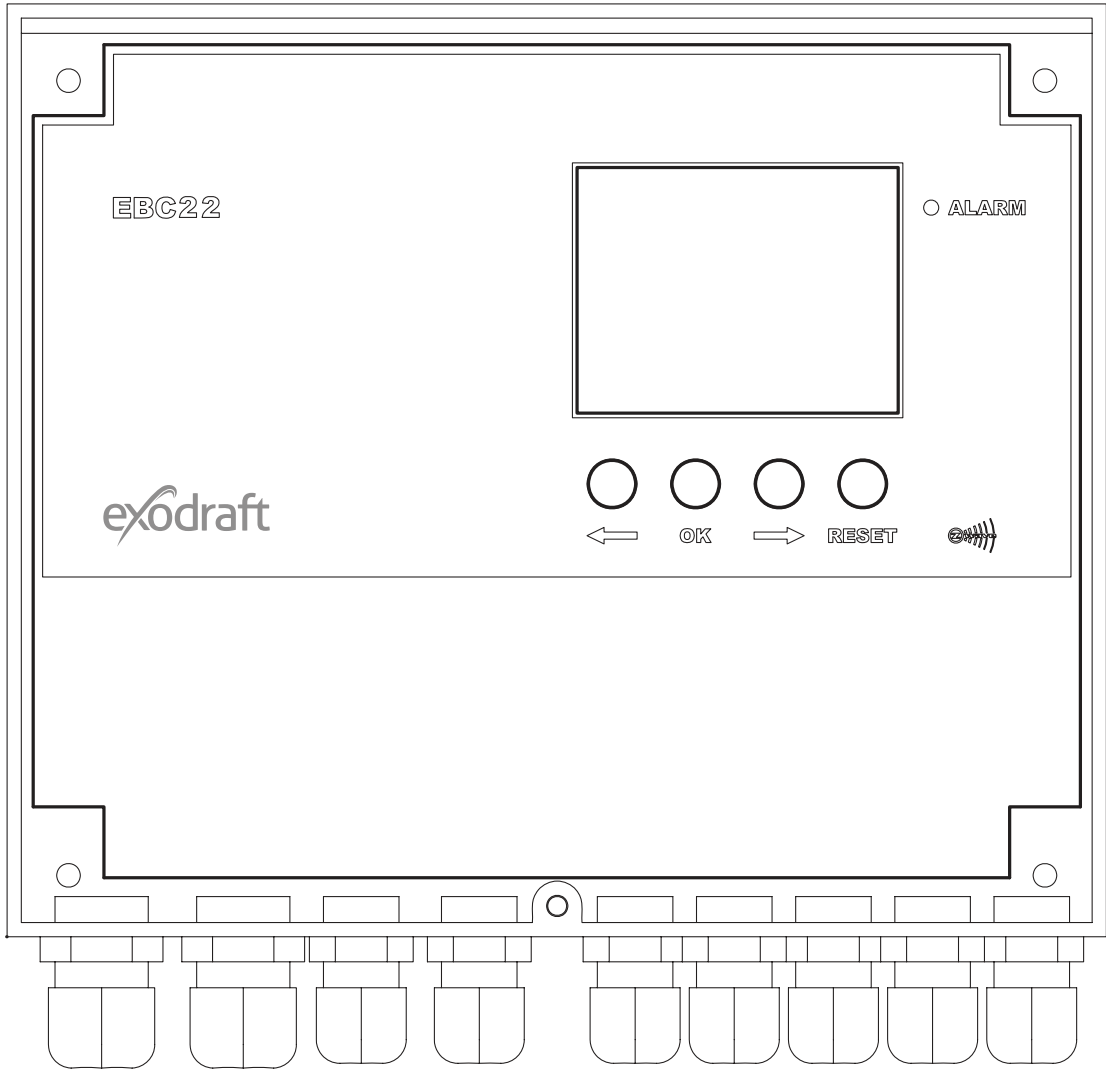

Control | EBC22

Content

Product information	8
Scope of supply	8
Accessories	8
Technical specifications	10
Construction and components	11
Components function	12
Fitting	12
Installation	13
Outdoor fitting of the pressure transducer (XTP)	14
Layout of the user interface	14
Light emitting diodes and terminal board	15
Display	16
Introduction to the user interface	17
Setup	17
Service Menu	18
Overview of the service menu	19
Changing between the operating functions	21
Pressure-controlled regulation of the chimney fan	23
Area of use	23
Method of operation	23
Electrical connection	24
Sample wiring diagrams	24
Single- or two boiler application	25
Single boiler application with potential free contact in boiler	26
Two boiler application with continuous operation of chimney fan	27
Solid fuel boiler with temperature sensor	28
User menu	29
Commissioning	30

2-stage speed regulation of Exodraft chimney fan	31
Area of use	31
Method of operation	31
Electrical connection	31
Sample wiring diagrams	31
1 x 2-stage boiler	32
2 x 1-stage boilers	33
User Menu	34
Set-up	35
Commissioning	36
Pressure-controlled regulation of Exodraft supply air fan	37
Use	37
Method of operation	37
Electrical connection	37
Sample wiring diagram	37
Connection of frequency converter/MPR relay	38
User menu	39
Set-up	40
List of alarms and troubleshooting	41
Alarm handling	41
Alarm overview	42
More troubleshooting	43
UK Conformity Assessed	44
Declaration of Conformity	45



How to use this manual

This manual has been prepared based on the specific product and contains relevant technical information and installations guides.

Accessories and spare parts are not covered by this manual. Please refer to the individual manuals of these components.

This installation manual does not contain any system design documentation.

Failure to observe instructions marked with a danger symbol may result in personal injury and/or damage to the product.

Errors and omissions excepted.



Disposal

Electrical and electronic equipment (EEE) often contain materials, components and substances that may harm the environment or be hazardous to your health. Products (WEEE) marked with the 'crossed-out wheeled bin' symbol should be disposed of separately from other waste at the end of its life. Though legislation may differ from country to country we strongly advise that electrical and electronic waste is separated from other waste and disposed of according to national legislation to protect the environment and personnel that may come into contact with waste.

Symbols

The following symbols may be used in the manual to draw attention to danger or risk of personal injury or damage to the product.



General prohibition

Failure to observe instructions marked with the prohibited symbol may result in extreme danger or serious personal injury.



General attention

Marks a dangerous situation that, in the worst-case scenario, can cause serious personal injury or significant damage to the product.



General warning

Failure to observe instructions marked with a danger symbol may result in personal injury and/or damage to the product.



Electricity hazard/High Voltage

Marks a situation in which caution is advised due to the risk of high voltage electric shock which can cause serious personal injury or significant damage to the product.



Connect an earth terminal to the ground

Failure to observe instructions marked with a danger symbol may result in personal injury and/or damage to the product.



Permitted and approved

Permitted and approved method of installation.



Prohibited and not approved

Prohibited and not approved method of installation.



Warning

To minimise the risk of fire, electric shock, personal injury and/or damage to the product please observe the following:

- Please always read the manual and only use the product in accordance with the manufacturer's instructions. If in doubt, contact one of the Exodraft specialized dealers.
- All installations must be carried out by properly qualified personnel in accordance with national legislation and regulations.
- This product must be earthed. Get assistance from an qualified electrician when in doubt.
- This product must always be disconnected under the installation.
- Prior to servicing the product, disconnect the power and ensure that it cannot accidentally be reconnected.
- Exodraft always recommends the use of a smoke alarm when a solid fuel open fire is installed.
- If the Exodraft fan system has been designed for solid fuel/multi fuel installations, please ensure that the design meets the requirements of BS EN15287-1. If this cannot be achieved, a smoke alarm must be installed in the same room as the heat appliance.

Product information

The EBC22 (Exodraft Boiler Control) is a specially designed control component for constant pressure regulation of chimney draft. EBC is specially designed to comply with the Gas Application Directive.

By changing the operating mode, the EBC22 can also:

- Act as a 2-stage speed regulator
- Control the supply of fresh air to the boiler room
- Automatically start/stop via a temperature sensor in the chimney duct

Incorrect use may result in problems with soot, chimney fires, etc. which might damage the product. Please check out this site for advice about the product:

www.exodraft.com

Scope of supply

- Exodraft EBC22 (EBC22EU01 for indoor installation/EBC22EU02 for outdoor installation)
- Pressure transducer (XTP)
- Measuring probe for EBC22EU01
- Measuring probe for EBC22EU02
- 2 m silicone hose
- Installation manual and user instructions

Accessories

The table below shows the accessories and spare parts available for the RHG-models.

Accessories*
Temperature sensor
Isolation switch
Realy box

*This manual does not describe the specific use of accessories. We refer to the separate manuals for such components.

For more details contact your Exodraft dealer.

Warranty

All Exodraft products are covered by a 2-year guarantee as per European consumer rights legislation. For some countries an extended period of guarantee may apply depending on either national legislation or other clearly stipulated conditions. Customer complaints must be handled by a specialised dealer or wholesaler (preferably where the Exodraft product has been bought originally). An updated list of Exodraft specialised dealers can be found on our website for the country in question.

Exodraft products must always be installed by properly qualified personnel. Exodraft reserves the right to change these guidelines without prior notice.

The warranty and liability does not cover instances regarding personal injury or damage to property or the product that can be ascribed to one or more of the following causes:

- Failure to follow this installation and operation manual
- Incorrect installation, start-up, maintenance or servicing
- Improper repairs
- Unauthorised structural modifications made to the product
- Installation of additional components that have not been tested/approved with the product
- Any damage resulting from continued use of the product despite an evident defect
- Failure to use original spareparts and accessories
- Failure to use the product as intended
- Exceeding or failure to meet the limit values in the technical data
- Force majeure

Technical specifications

The EBC22 is an automatic control system for single and multiple gas boiler installations and for other installations in which singular or multiple heat sources are connected to the same chimney. The control may only be used with Exodraft fans. The EBC22 system consists of an EBC22 controller, which can be positioned anywhere, and a pressure transducer (XTP 150G sensor) which is positioned near the chimney. The EBC22 control is approved accordingly to the gas directive by Kiwa Gastec.

The EBC22 controller monitors and maintains a specific draught by maintaining a constant pressure. The pressure in the chimney is measured by the XTP 150G sensor. If the draught falls outside the set point value the speed of the fan is modulated to achieve the target draught. If it is not possible to maintain the draught at or above the set point then the controller will automatically disconnect the boiler(s).

Technical data

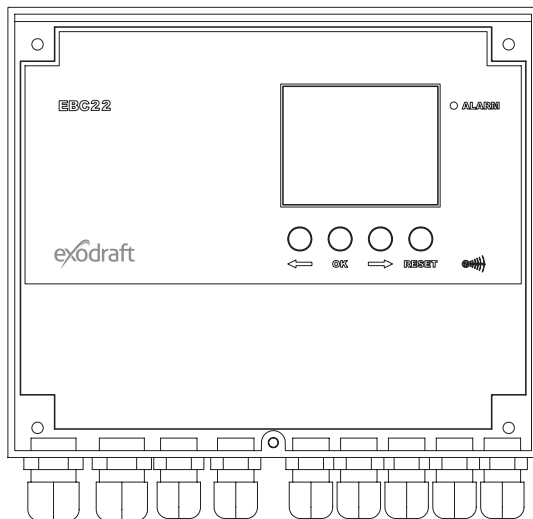

Data	EBC22
H x W x D [mm]	204,3 x 239,5 x 77,2
Weight	1,62 kg
IP-rating / material	IP54 / ABS PA758
Voltage	230 V AC ± 10 %, 50 Hz ± 1 %
Max power consumption	475 W
Fuse	T4A
Temperature	-20 °C to 60 °C
Monitoring range	-500 Pa to +500 Pa

Construction and components

1	EBC22 (EBC22EU01/ EBC22EU02)
2	XTP150 G - Pressure transducer
3	Measuring probe for EBC22EU01
4	Measuring probe for EBC22EU02
5	Silicone hose

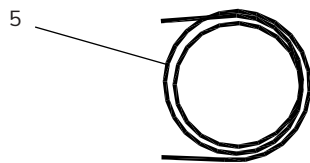
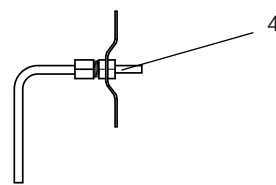
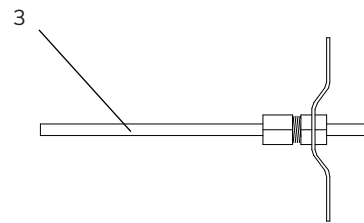
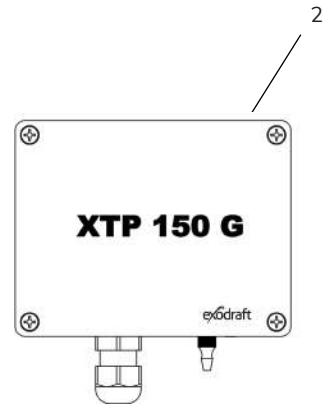
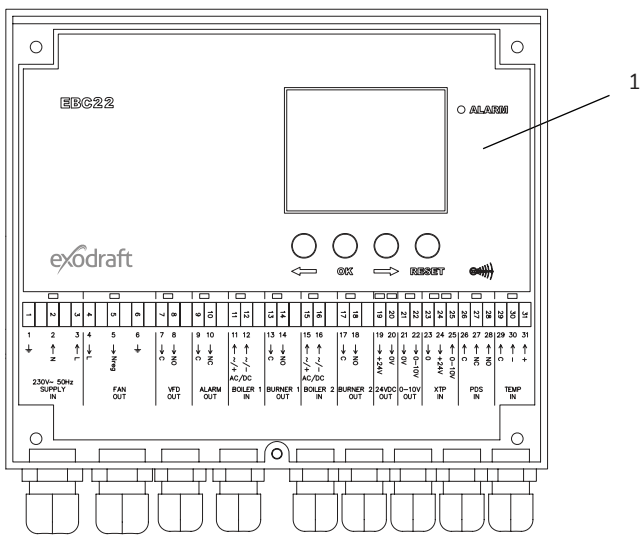

Components function

Item no.	Part	Function
EBC22EU01	EBC22	Controls Exodraft fans and chimney fans. For indoor installations.
EBC22EU02		Controls Exodraft fans and chimney fans. For outdoor installations.
XTP150G	Pressure transducer (XTP)	Measures difference air pressure in the boiler room or chimney, or outdoor atmospheric pressure.
3200814	Measuring probe for EBC22EU01	Measures pressure in the chimney. (EBC22EU01)
3200484	Measuring probe for EBC22EU02	Measures pressure in the chimney. (EBC22EU02)
2000335	2 m silicone hose	Supplies the pressure transducer (XTP) with reference pressure from the measuring probe or from outdoors.
1100755	Temperature sensor	Measures the temperature
ES12	Relay Box	If more than 2 boilers are connected

Fitting

Max. cable length between EBC22 and XTP: 100 m.

Max. cable length between EBC22 and chimney fan / fan: 100 m

Installation

The EBC22 is to be fitted and connected as shown in the diagram below.

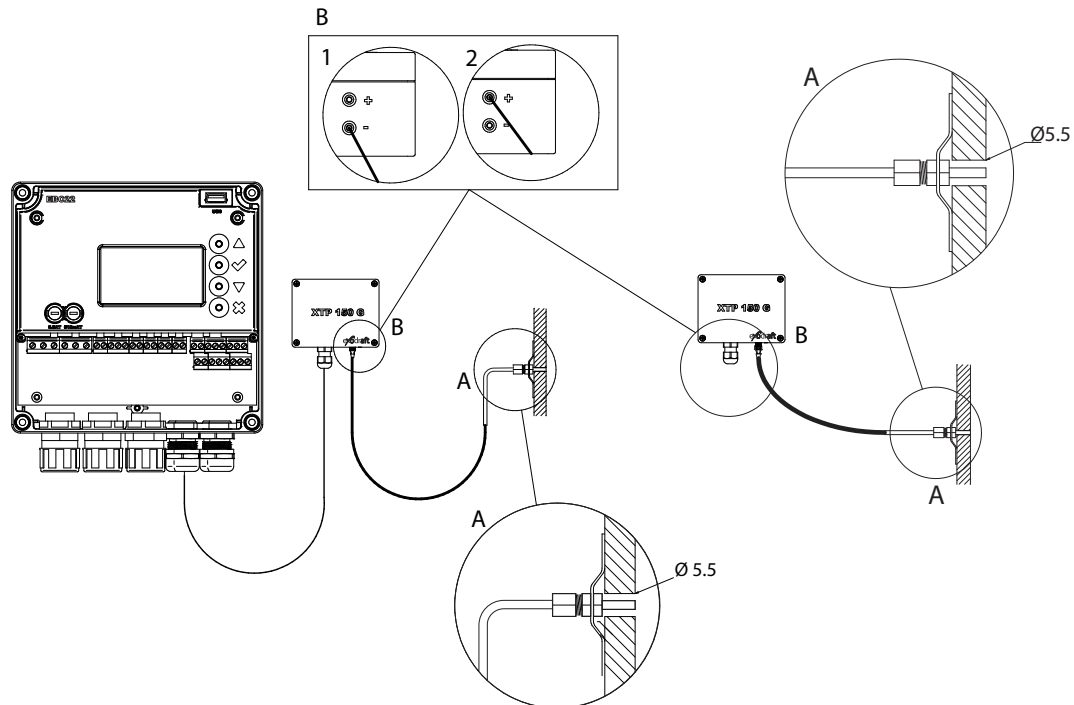

Control of...	Fitting procedure
Chimney fan	<ul style="list-style-type: none"> Fit the EBC22 and the pressure transducer (XTP) in the boiler room. Fit the measuring probe(A) in the boiler flue or in the manifold. However, for atmospheric boilers, the probe must always be positioned after the draft hood. Connect the hose from the measuring probe to the negative terminal on the pressure transducer (B"1"). When the measuring probe is placed outside it must be mounted in a way that prevents condense or ice to be formed. EBC22EU02 is delivered with a straight measuring probe. If necessary the probe delivered with EBC20EU01 can be straightened and placed so the condens can run out. EBC20 must always be mounted in a way that protects it from the weather (Rain, snow etc.).
Supply air fan	<ul style="list-style-type: none"> Fit the EBC22 and pressure transducer (XTP) in the boiler room. Connect the hose for measuring reference pressure (outdoor atmospheric pressure) to the negative terminal (B"1") on the pressure transducer. Run the hose outside the building to a place that is not affected by wind, rain, etc. If appropriate, fit the free end of the hose in a box as described at the top of the next page.
Note!	<ul style="list-style-type: none"> Special aspects if you require positive pressure* in the chimney/boiler room: Connect the hose to the positive terminal on the pressure transducer (B"2") In menu 16 (see page 20) set the value to 2 (positive pressure). For operation of the service menu, see page 19 Please note that the EBC22 is supplied with only 2 m of hose.



*The default setting of the EBC22 is for negative pressure regulation, but local authority requirements may state that positive pressure must be maintained.



The pressure transducer cannot be mounted inside an air tight enclosure. It uses the atmospheric pressure as reference pressure.

Outdoor fitting of the pressure transducer (XTP)

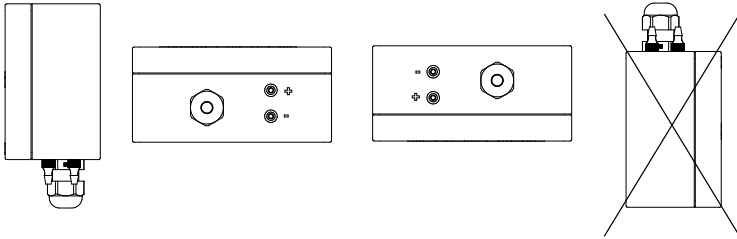

If there is a risk of adverse effect from strong winds, the hose (A) located inside the XTP 150G can be removed from the (+) valve.

If the pressure transducer is positioned in a place where insects have access to the free end, fitting a sinter filter is recommended.

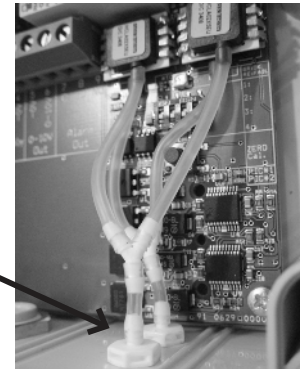

Make sure to position the pressure transducer the right way up.



Do not blow into the valves on the XTP 150 G

Layout of the user interface

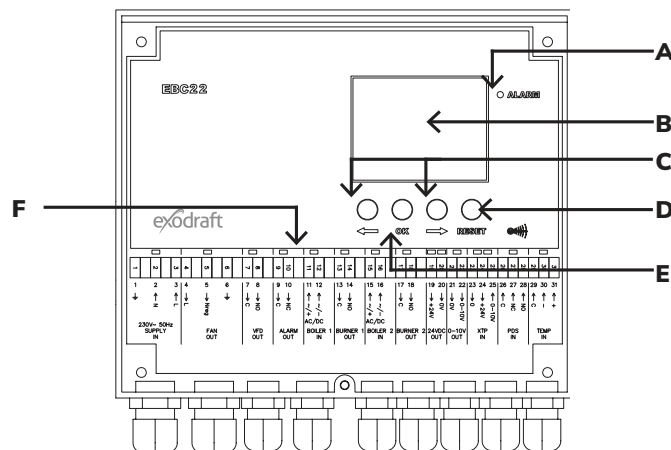

Pos.	Part	Function
A	Alarm	<ul style="list-style-type: none"> indicates alarms
B	Display	<ul style="list-style-type: none"> displays operation and changes in the user interface (menu system) indicates alarms shows normal operation status
C	← and →	<ul style="list-style-type: none"> forward or back in the menu system increase/reduce set point
D		<ul style="list-style-type: none"> reset alarm return to operation screen
E		<ul style="list-style-type: none"> select menu item confirm/save change of set point (must be confirmed with OK (the current set point blinks rapidly) and is saved using OK within 5 seconds (or the setting will not be saved)
F	Light emitting diodes	<ul style="list-style-type: none"> shows status of inputs and outputs

Display

The diagram below shows the layout of the display on the EBC22. All possible display values are stated:

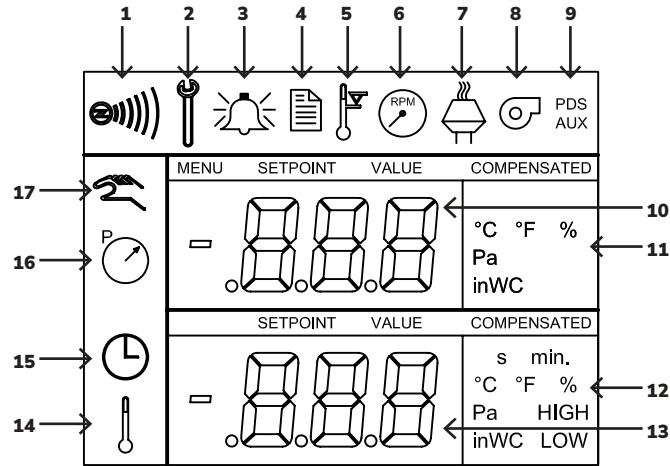

Pos.	Shows
1	Symbol indicating the connection of Z-wave
2	Symbol for service menu
3	Symbol for alarms. Displayed in the event of an alarm, along with the illumination of the alarm diode.
4	Symbol for the operational settings of the service menu (see section 1.6) and the alarm log.
5	Symbol for overheating
6	Symbol for 2-stage speed regulation of Exodraft chimney fan
7	Symbol for pressure-controlled regulation of Exodraft chimney fan
8	Symbol for pressure-controlled regulation of Exodraft supply air fan
9	Symbol indicating: <ul style="list-style-type: none"> • PDS error • PDS check (flashing)
10	Operation screen: current pressure <ul style="list-style-type: none"> • Menu screen: current menu
11	Units
12	Units
13	Menu screen ("VALUE" and, in some cases, "SETPOINT" displayed): Setpoint for the menu item in question
14	Temperature symbol, indicates: <ul style="list-style-type: none"> • Operation screen: current temperature • Menu screen: temperature parameter setting
15	Timer indicator
16	Pressure symbol indicating that: <ul style="list-style-type: none"> • Operation screen: Pos. 10 is displaying pressure • Menu screen: You are currently altering a pressure parameter
17	Symbol for commissioning

Introduction to the user interface

Display

The purpose of the display (see previous page) is to present:

- Operating information (pressure, etc.)
- Alarms
- Setpoints
- Parameters



Menu structure

The menu system in the EBC22 contains:

- User menu (for operation by daily users).
- Service menu (for operation by qualified technical staff).

Layout of the user interface

The user interface is operated through four buttons with the following functions:

Button	Function
	<ul style="list-style-type: none"> • Activate the user menu • Edit and save settings • Activate service menu (press and hold for 3 seconds)
	<ul style="list-style-type: none"> • Go to menu item, and adjust value
	<ul style="list-style-type: none"> • Return to operation screen from any point in the menu system • Reset alarm when manual reset is selected in menu 25, see page 20

Setup

Setting the chimney draft

To set the pressure in the chimney, follow the procedure detailed below

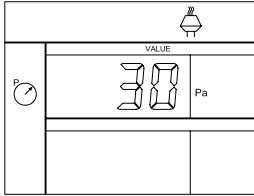
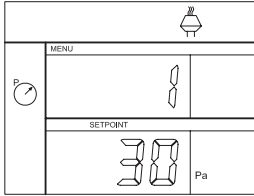
Step	Action	The display shows...
1	<ul style="list-style-type: none"> • Start the heating system. • The EBC22 displays the actual pressure (in this example 30 Pa). 	
2	<ul style="list-style-type: none"> • Briefly press to enter the user menu. 	

- 3
- Press **OK**
 - Press **←** and **→** until the required pressure appears in the lower display.

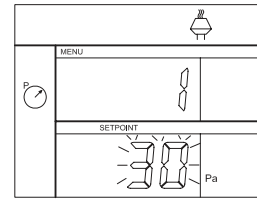

- 4
- Press **OK** to confirm the setting (the display blinks faster)

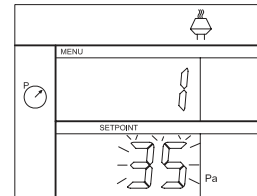

- 5
- Within 5 seconds, press **OK** again, to save the set pressure (35 Pa in this example).

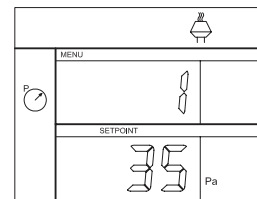

- 6
- To finish and return to the operation screen, press **RESET**

NB! This procedure only applies to setting up the chimney draft. If you wish to:

- Set the EBC22 up for 2-stage speed regulation of a chimney fan, see page 31
- Set the EBC22 up for pressure control of a supply air fan, see page 37

Service Menu

The service menu is only to be operated by qualified staff. For an overview of the **service menu**, see page 20-21.

Navigation in the service menu

- To activate the service menu, press and hold **OK** for 3 seconds

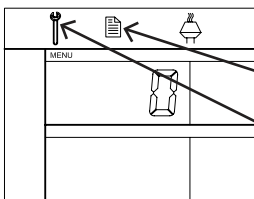

The service menu operation settings









Service menu



Operation is carried out using the buttons as described above.

- The upper display (on page 17) presents the number of the menu, with the set point for this menu being shown in the lower display (on page 17).
- Menus whose last digit is "0" are exit menus. These are used to navigate one level back. To do so, press
- To activate the editing options for a menu item, press **OK**. The set point will start flashing.
- Confirm selection with **OK**.
- Save by pressing **OK** again within 5 seconds.
- To exit the service menu, press **RESET**. This will take you back to the operation screen. Alternatively, you can navigate back one level at a time if you wish to set multiple menu items.

Overview of the service menu

The service menu is built up in four levels:

Menu level 1	Menu level 2	Menu level 3	Function	Base settings for the three applications				
				 Default	 RSP10	 RSP15		
0	Exit Service menu		Return to operation screen					
1	10	Exit operation settings						
	11	Operating mode	Setting of control/operating function 1 = Pressure-controlled regulation  2 = 2-stage speed regulation  3 = Supply air regulation 	1				
	12	°C / °F	Select measuring unit for temperature 1 = °C, 2 = °F	1 (°C)	1 (°C)	1 (°C)		
	13	Pa / inWC	Measuring unit for pressure: 1 = Pa, 2 = inWC	1 (Pa)	1 (Pa)	1 (Pa)		
	14	Software versions	140	Exit				
			141	Controller version	View Controller software version	x.xx	x.xx	x.xx
			142	Safety version	View Safety software version	x.xx	x.xx	x.xx
			143	Display version	View Display software version	x.xx	x.xx	x.xx
	15	Select XTP measurement range	150	Exit				
			151	Set Low XTP value	from -500 Pa to 0 Pa	0 Pa	N/A	0 Pa
			152	Set High XTP value	from 0 Pa to 500 Pa	150 Pa	N/A	150 Pa
	16	Positive/negative pressure		1 = negative pressure 2 = positive pressure	1	N/A	1	
	17	OEM functions	170	Exit				
			171	Cooker function	Switch Cooker function ON and OFF	N/A	OFF	N/A
18	Reset to defaults		Reset to defaults. If you select "YES", a 10-second countdown will start, during which you can cancel your choice by pressing any button.	NO	NO	NO		
2	20	Exit Alarm						
	21	Alarm Log	210	Exit				
			211 -219	The 9 most recent alarms				
	22	Reset alarm log		Resets alarm log	NO	NO	NO	
	23	Flow Alarm limit		Set Flow Alarm limit in %:  : 50-80% (Alarm when pressure is below xx%)  : 100-300% (Alarm when pressure is above xx%)	64%	N/A	300%	
	24	Flow Alarm delay		Set Flow Alarm delay, 10-60 s	15 s	15 s	15 s	
	25	Reset auto / manual		1 = automatic, 2 = manual	1 Auto)	1 (Auto)	11 (Auto)	











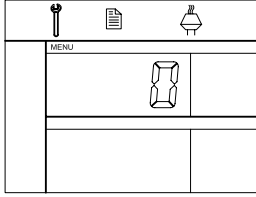

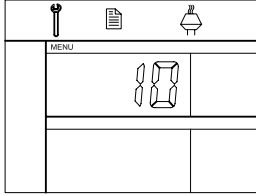

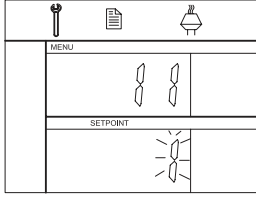

				Base settings for the three applications				
Menu level 1	Menu level 2	Menu level 3	Function	 Default				
3 Configuration	30	Exit settings						
	31	PDS/AUX config		1 = PDS, 2 = C-NO	2 (C-NO)	1 (PDS) (Locked)	2 (C-NO)	
	32	Triac settings	320	Exit				
			321	Umin	Min. output voltage in % of 230V AC, 35-100%	35%	N/A	35%
			322	Umax	Max. output voltage in % of 230V AC, 35-100%	100%	N/A	100%
	33	0-10V settings	330	Exit				
			331	Umin	Min. output voltage in % of 10V DC, 0-100%	0%	N/A	0%
			332	Umax	Max. output voltage in % of 10V DC, 0-100%	100%	N/A	100%
	34	Manual Fan mode	340	Exit				
			341	Manual Fan mode on/off	Switch Manual Fan mode on and off	OFF	OFF	OFF
			342	Manual Fan mode speed	Set the motor manually, 35-100%	35%	35%	35%
	35	Regulation parameters	350	Exit				
			351	Amplification Xp	Set proportional amplification, 0.2 to 5	2,2	N/A	1,2
			352	Integration time Ti	Set integration time from 1 to 30 s	5	N/A	3
			353	Differential time Td	Set differential time from 1 to 30 s	1	N/A	5
354			Sample time	Set sample time from 1 to 999 ms	300 ms	N/A	300 ms	
4 Temp. sensor	40	Exit Temp. sensor						
	41	Sensor ON/OFF		turn temperature sensor ON/OFF	OFF		OFF	
	42	Auto Start/Stop	420	Exit				
			421	ON/OFF	turn temperature sensor ON/OFF	OFF		OFF
			422	Start temperature	select start temperature in 5-450 °C range	40 °C		40 °C
			423	Stop temperature	select stop temperature in 0-445 °C range	35 °C		35 °C
	43	Forced operation	430	Exit				
			431	ON/OFF	turn forced operation ON/OFF	OFF		OFF
			432	Limit temperature	select temperature limit in 5-450 °C range	250 °C		50 °C
	44	Alarm	440	Exit				
			441	ON/OFF	turn alarm ON/OFF	OFF		OFF
442			Limit temperature	select temperature limit in 25-450 °C range	450 °C		450 °C	
443			Alarm delay	Select delay-length of limit temperature alarm: 0-60 second range	5		5	

Changing between the operating functions

Default operating function

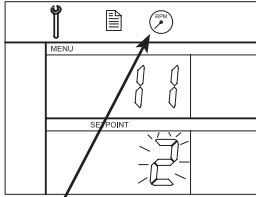
As its base function, the EBC22 is factory set to pressure-controlled regulation of Exodraft chimney fans (operating function 1)

How to change the operating function

Step	Action...	The display shows...									
1	<ul style="list-style-type: none"> Press and hold  for 3 seconds 										
2	<ul style="list-style-type: none"> Press  to go to menu 1. Press  to go to menu 10. 										
3	<ul style="list-style-type: none"> Press  to go to menu 11 Press  										
4	<p>Press  until the symbol and number for the operating function you require is displayed. The three operating functions are:</p> <table border="1"> <tr> <td>1</td> <td>Pressure-controlled regulation of Exodraft chimney fans (default)</td> <td></td> </tr> <tr> <td>2</td> <td>2-stage speed regulation of Exodraft chimney fans</td> <td></td> </tr> <tr> <td>3</td> <td>Pressure-controlled regulation of Exodraft supply air fan</td> <td></td> </tr> </table>	1	Pressure-controlled regulation of Exodraft chimney fans (default)		2	2-stage speed regulation of Exodraft chimney fans		3	Pressure-controlled regulation of Exodraft supply air fan		 <p>symbol is changed</p>
1	Pressure-controlled regulation of Exodraft chimney fans (default)										
2	2-stage speed regulation of Exodraft chimney fans										
3	Pressure-controlled regulation of Exodraft supply air fan										

- 5
- Press **OK** to confirm selection (the display blinks faster)

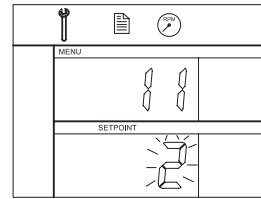

- 6
- Within 5 seconds, press **OK** again, to save selection. (display stops blinking).

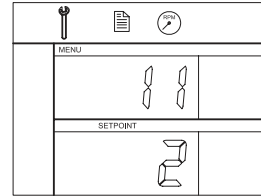

- 7
- To finish and return to the operation screen, press **RESET**

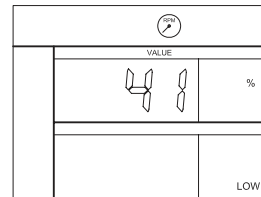

Pressure-controlled regulation of the chimney fan

Area of use

- The EBC22 is designed for use with boiler systems with 1- and 2-stage burners.
- The EBC22 can also be used for boiler systems with modulating burners.
- The EBC22 can also be used for multiple boiler systems
- The control system is intended for:
 - solid fuel boilers,
 - atmospheric gas boilers
 - forced draft boilers for oil and gas
 - condensing boilers.
- The EBC22 can control a chimney fan directly or indirectly via a frequency converter.

Method of operation

General function

- The control system monitors chimney draft and disconnects the burner in the event of errors (the alarmdiode on the EBC22 will turn on).
- When the boiler thermostat demands heat, the chimney fan will start at max. voltage, the burner start is delayed
- When the EBC22 registers sufficient chimney draft, the burner is released.
- The EBC22 maintains the set pressure by regulating the voltage. The pressure is shown in the display.
- In the event of an insufficient pressure the burner will be disconnected after 15 seconds. "Insufficient pressure" is less than 64% of the set value, corresponding less than 80% flow.
- When the boiler switches off, the chimney fan is also stopped. However, it is possible to set a post-purge period for the chimney fan (see page 29). Alternatively, the control system can be set up to keep the chimney fan running continuously (see page 27).

Light emitting diodes and output signals

All inputs and outputs are linked to light emitting diodes for the monitoring and service of the system (1.4.2 Light emitting diodes and terminal board, page 16).

The EBC22 has 0–10V output signals for controlling multiple chimney fans via frequency converters or motor power relays.

Electrical connection

This work must be performed by a qualified electrical engineer, in accordance with locally applicable rules and legislation.

The installation of the supply cable must be carried out in accordance with applicable regulations and legislation.

The earth terminal (\perp) must always be connected.

When connecting pressure transducer (XTP) and frequency converter, screened cable must be used.

Isolation switch

Exodraft stresses that according to EU's Machinery Directive an isolation switch must be set up in the fixed installation.

The isolation switch is not supplied by Exodraft. Available as an extra.

Sample wiring diagrams

As a constant pressure regulator for Exodraft chimney fans, the EBC22 can be connected to a range of different signals.

The following pages are sample wiring diagrams, and show the following

- Single- or two boiler application
- Single boiler application with potential free contact in boiler
- Two boiler application with continuous operation of chimney fan
- Solid fuel boiler with temperature sensor

Single- or two boiler application

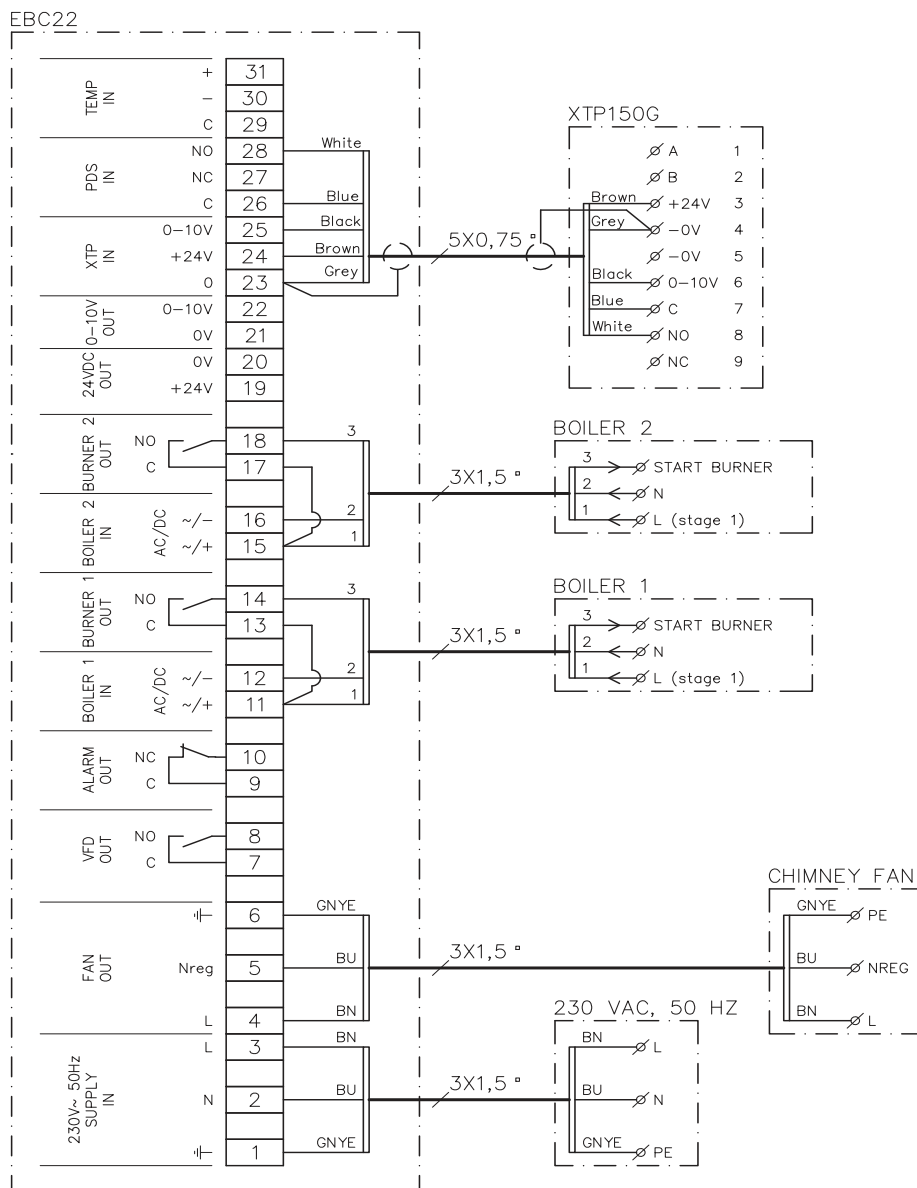

This example shows how to connect a voltage signal (10–230V AC/DC) for the EBC22 to start/stop the fan from one or two independent boilers

- Connect the supply voltage to terminals 1–3
- Connecting the boilers:
 - Connect the burner start signal (L) to terminal 11 & 15
 - Connect the neutral wire to terminal 12 & 16
 - The start signal for the burner is sent from terminal 14 & 18
- Loop terminals 11 and 13
- Loop terminals 15 and 17
- Connect the chimney fan to terminals 4–6
- Connect the pressure transducer (XTP) to terminals 23–28

Single boiler application with potential free contact in boiler

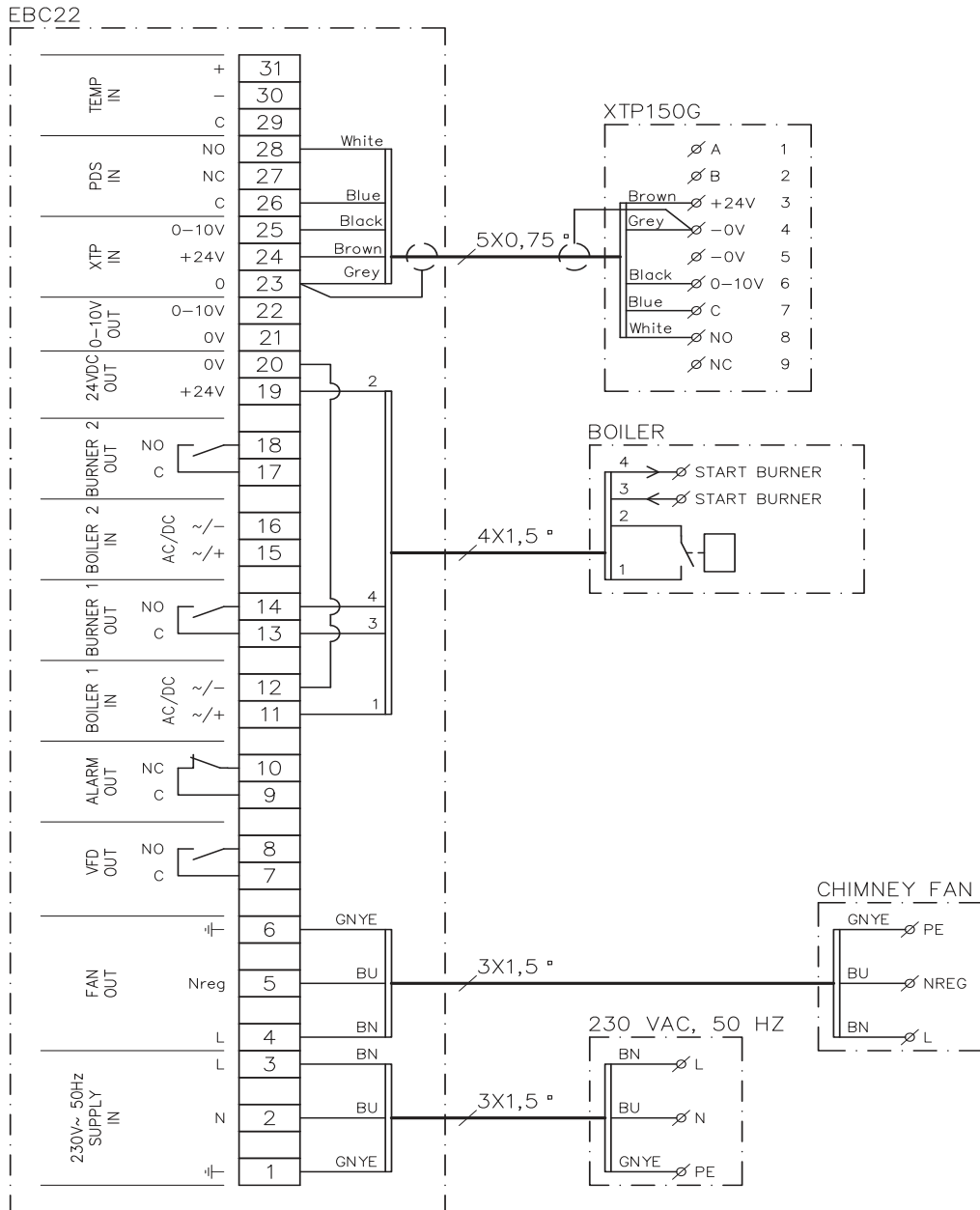

This example shows how to connect a potential free contact to the EBC22 to start/stop the fan

- Connect the supply voltage to terminals 1–3.
 - Connection to the boiler:
 - Connect the potential free contact to terminals 11 & 19.
 - Loop terminals 12 & 20.
- Connect the burner start signal to terminals 13 & 14.
- Connect the chimney fan to terminals 4–6.
- Connect the pressure transducer (XTP) to terminals 23–28.

Two boiler application with continuous operation of chimney fan

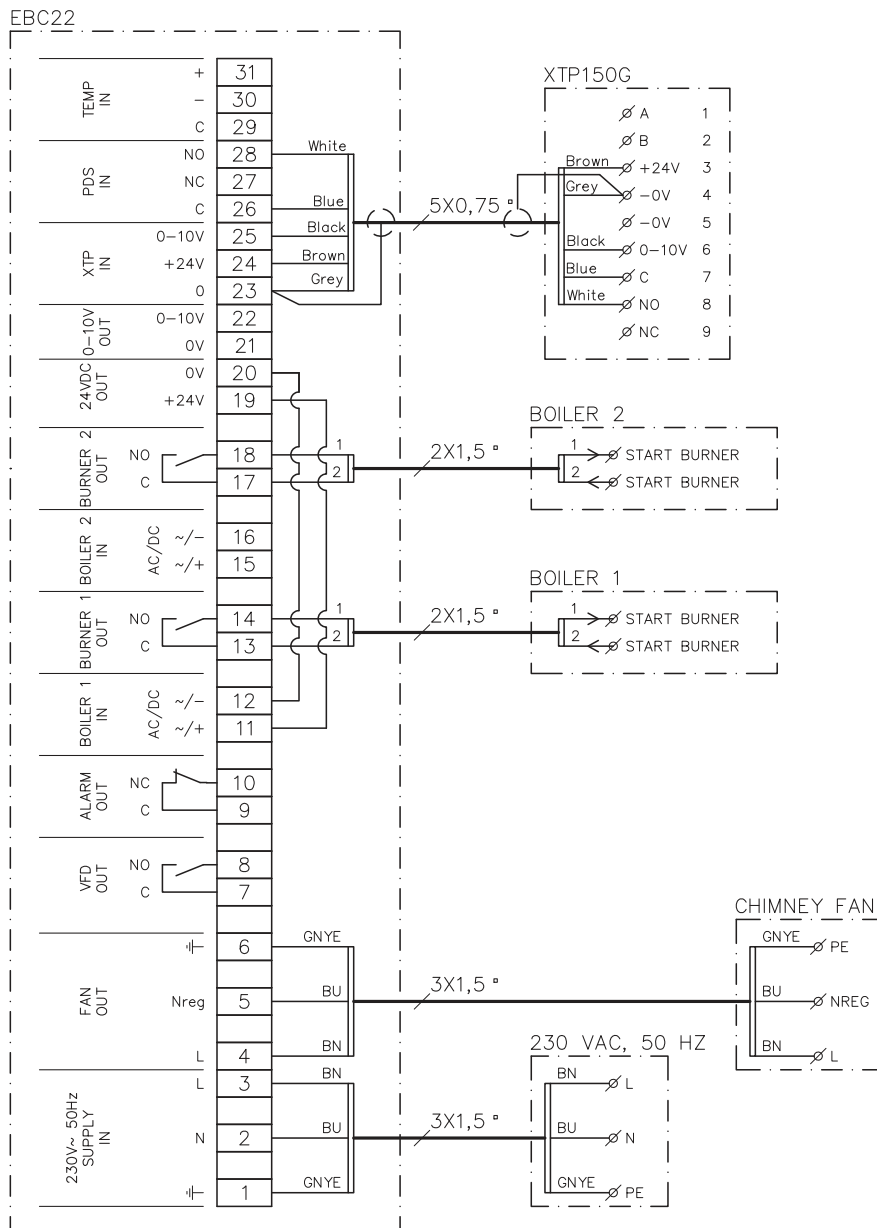

This example shows how to connect the EBC22 if you require continuous operation of the chimney fan from one or two boilers

- Connect the supply voltage to terminals 1–3.
- Loop terminals 11 & 19.
- Loop terminals 12 & 20.
- Connection to boiler (example with 2 boilers):
 - Connect the boiler 1 start signal to terminals 13 & 14.
 - Connect the boiler 2 start signal to terminals 17 & 18.
- Connect the chimney fan to terminals 4–6.
- Connect the pressure transducer (XTP) to terminals 23–28.

Solid fuel boiler with temperature sensor

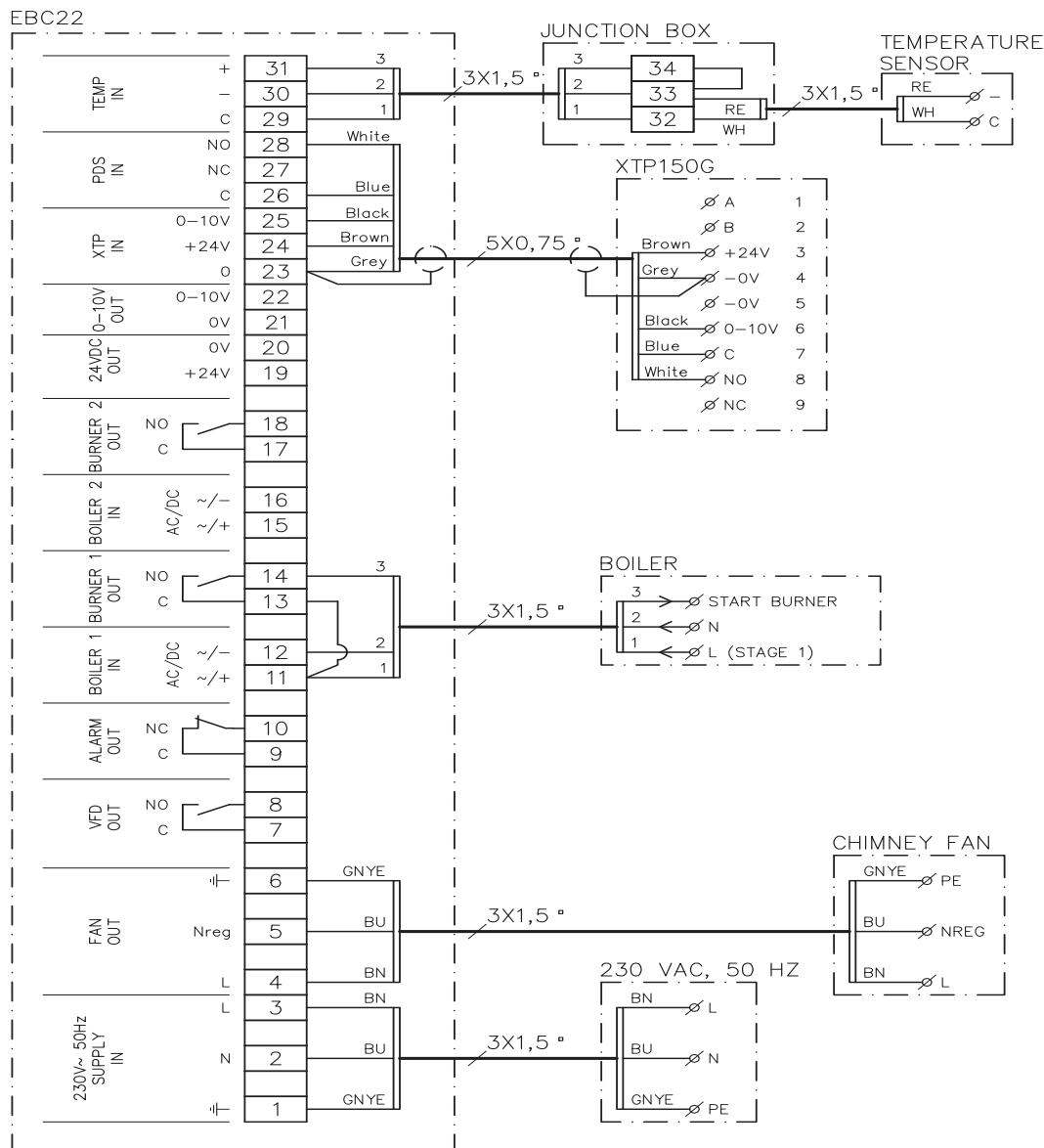

Example showing how a fan start/stop temperature sensor is connected to the EBC22

- Connect the supply voltage to terminals 1–3
- Connecting the boiler:
 - Connect the burner start signal (L) to terminal 11.
 - Connect the neutral wire to terminal 12.
 - Loop terminals 11 and 13.
 - The start signal for the burner is sent from terminal 14
- Connect the fan to terminals 4-6.
- Connect the pressure transducer (XTP) to terminals 23–28.
- Connect the temperature sensor through a junction box to terminals 29-31

User menu

Layout of the user menu

The user menu consists of a single level and provides access to 4 parameters:











Menu	Function	Range
1	Setting the required pressure	Depending on the XTP-range set in menus 151 and 152
2	Setting pre-purge period	0-999 s
3	Setting post-purge period	0-60 min
4	Displaying current alarm (see alarm overview page 34)	-



When the instructions refer to the menu numbers 1,2,3 and 4 it is understood that these numbers refer to the user menus.

Operating the user menu

Adjust the set point for user menu items 1–4 in the same way as shown in the example on page 17.

To operate menu items 1–4, use the buttons as follows:

Step	Press...	To...
1		Activate the user menu
2	 and 	Go to the menu item you wish to edit
3		Edit the menu item selected
4	 and 	Adjust the required set point
5		Confirm the required set point
6		To save the required set point: Press OK again within 5 seconds
7		Return to operation screen. NB: If you do not press  the EBC22 will automatically return to the operation screen after 30 seconds

You can always undo an action (that you have not confirmed by pressing ) and return to the operation screen by pressing .

Commissioning

Commissioning on the EBC22 must be carried out to ensure a correct draft from the system.



Commissioning should be carried out by staff with the appropriate training, and with the authorisation to do so according to local legislation.

Do as follows:

Step	Action...
1	Provisional draft setting (negative pressure): <ul style="list-style-type: none"> • Press OK to go to Menu 1. • Press OK • Press ← or → until the negative required pressure appears in the display. • Press OK to confirm the set point. • To save the set point: Press OK again within 5 seconds. • Press RESET to return to the operation screen.
2	<ul style="list-style-type: none"> • Start the system. • Wait until the boiler starts and the draft has stabilised. The current draft will be shown in the display
3	Final adjustment of draft: <ul style="list-style-type: none"> • Check the draft on the boiler. • If draft is not correct, repeat the procedure from step 1.
4	Check that the monitoring system shuts off the boiler. To simulate an error situation, disconnect the hose from the pressure transducer (XTP). Burner is switched off (diode switches off) and the alarm diode illuminates.
5	After completing the commissioning, check the start-up function by restarting the system.

For the set point values, please refer to the data for the boiler in question. However, the following values can be considered typical:

- Boilers with forced draft: typically 20–30 Pa
- Boilers with atmospheric burners: typically 5–10 Pa

Set up according to site conditions can be determined by boiler commissioning engineer.

2-stage speed regulation of Exodraft chimney fan

Area of use

- The EBC22 can be used as a 2-stage speed regulator for an Exodraft chimney fan.
- The control system is intended for 1- or 2-stage atmospheric gas boilers.
- The EBC22 can control a chimney fan directly or indirectly via a frequency converter

Method of operation

General function

- The EBC22 monitors chimney draft and disconnects the boilers in the event of errors (the alarmdiode on the EBC22 will turn on).
- When the boiler thermostat demands heat, the chimney fan will start at max. voltage.
- When the monitoring system measures sufficient chimney draft, the burner is released, and voltage to the chimney fan is regulated according to the setpoint for stage 1 (LOW).
- When stage 2 (HIGH) is activated, the EBC22 regulates the voltage to the chimney fan according to the set point for stage 2.
- It is possible to set pre-purge and post-purge periods for the chimney fan.
- In the event of insufficient draft, the burner will be disconnected after 15 seconds. "Insufficient draft" is draft less than the value set on the PDS during commissioning.

Step-up function

- The step-up function in the EBC22 prevents unintentional disconnection of the system on account of changes in wind and weather conditions.
- The step-up function performs a stepped increase of the voltage as a result of protracted draft errors. In principle, this can be repeated until maximum voltage has been reached.

Electrical connection



This work must be performed by a qualified electrical engineer, in accordance with locally applicable rules and legislation.



The installation of the supply cable must be carried out in accordance with applicable regulations and legislation.

The earth terminal () must always be connected.



Exodraft A/S stresses that in accordance with EU's Machinery Directive an isolation switch must be set up in the fixed installation.

The isolation switch is not supplied by Exodraft. Available as an extra.

Sample wiring diagrams

As a 2-stage speed regulator for Exodraft chimney fans, the EBC22 can be connected to a range of different signals. The following sections contain two sample wiring diagrams showing:

3.4.1 1 x 2-stage boiler, page 32

3.4.2 2 x 1-stage boilers, page 33



Exodraft recommends that you contact the boiler manufacturer for details of correct connection of the boiler control system.

1 x 2-stage boiler

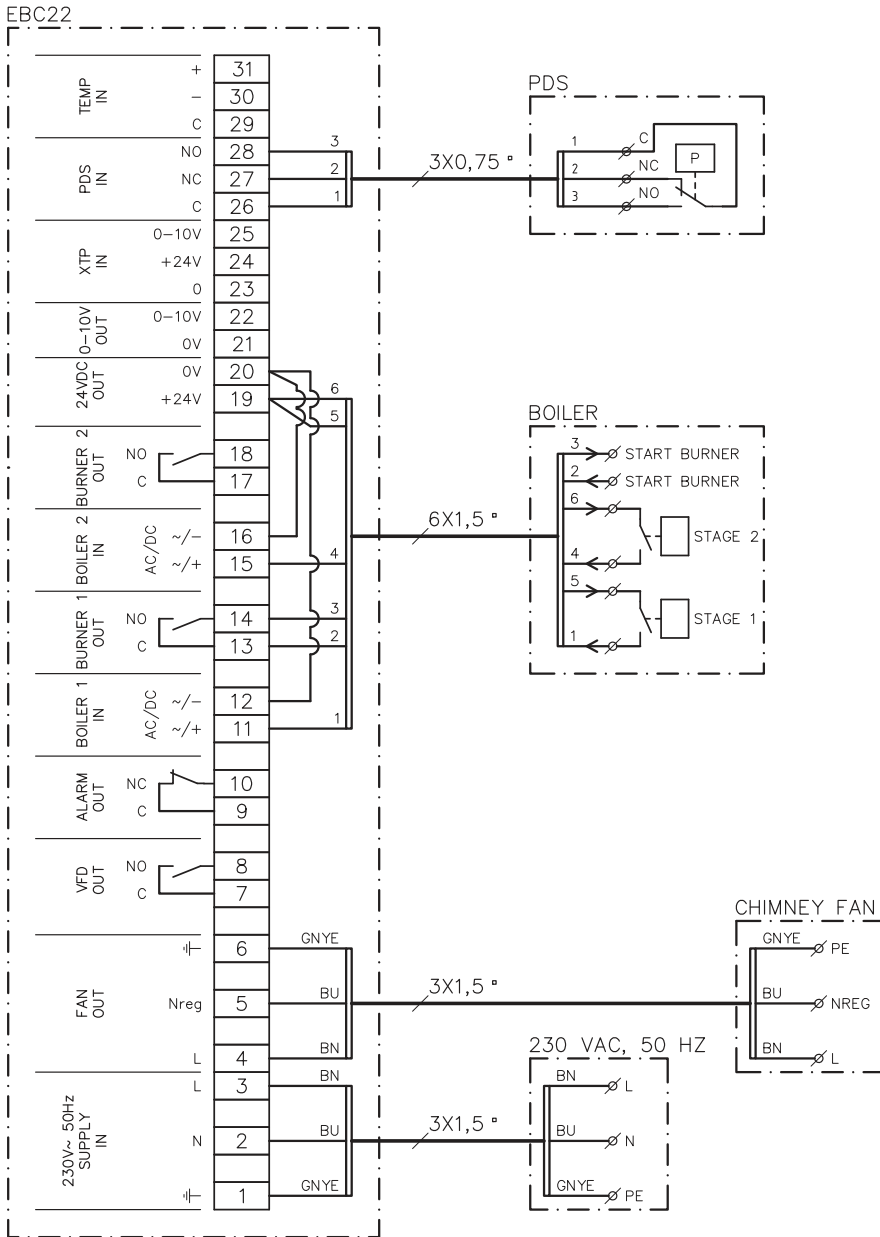

This example shows which inputs/outputs on the EBC22 need to be connected to a 2-stage boiler:

The boiler outputs for stages 1 & 2 are two potential free contact sets.

Connect the supply voltage to terminals 1–3.

- Loop terminals 12 & 20.
- Loop terminals 16 & 20.
- Connection to the boiler:
 - Connect stage 1 (potential free contact) to terminals 11 and 19.
 - Connect stage 2 (potential free contact) to terminals 15 and 19.
 - Connect the burner start signal to terminals 13 & 14.
- Connect the chimney fan to terminals 4–6.
- Set the value in menu 31 to 1 (PDS connected).

NB: If $\frac{PDS}{AUX}$ is flashing, the EBC22 is preparing for a PDS-check.

2 x 1-stage boilers

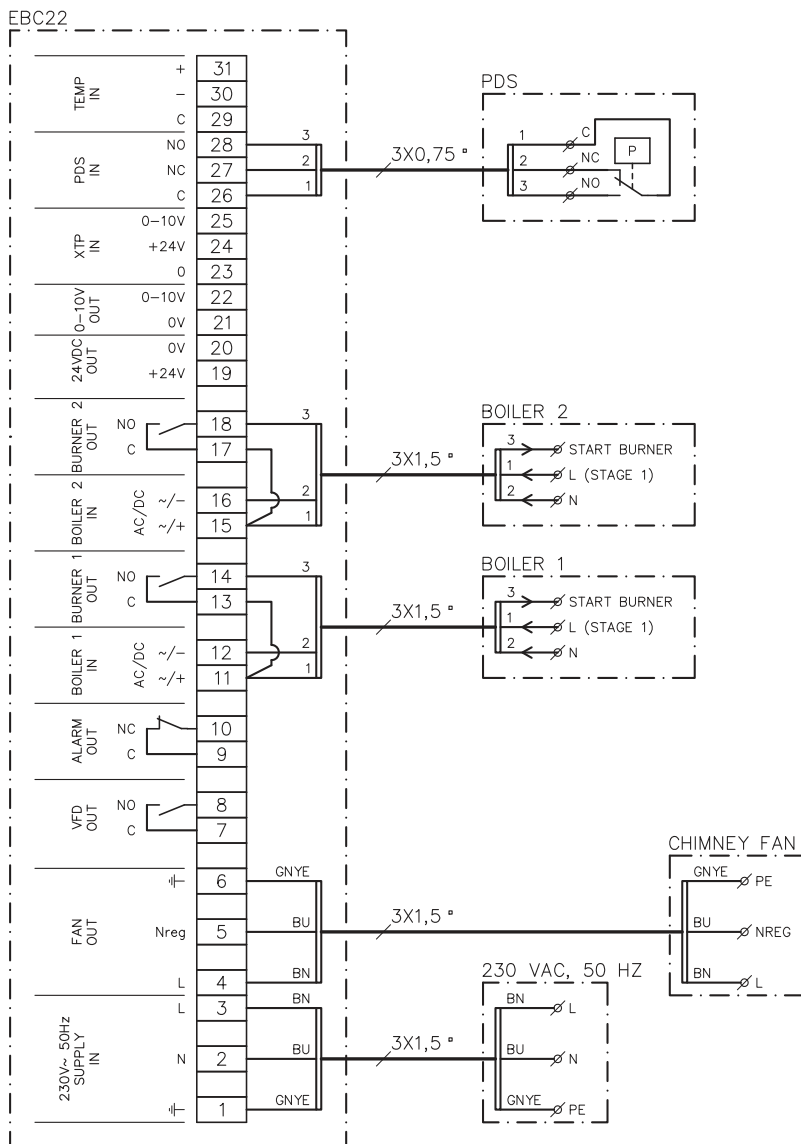

This example shows which inputs/outputs on the EBC22 need to be connected to 2 x 1-stage boilers. The boiler output for stage 1 is a voltage signal.

Connect the voltage to terminals 1–3.

- Loop terminals 11 & 13.
- Loop terminals 15 & 17.
- Connection to the boilers:
 - The start signal for the burner from boiler 1 is connected to terminal 14.
 - Connect boiler 1 (N) to terminal 12.
 - Connect the start signal for boiler 1 (L) to terminal 11.
 - The start signal for the burner from boiler 2 is connected to terminal 18.
 - Connect boiler 2 (N) to terminal 16.
 - Connect the start signal for boiler 2 (L) to terminal 15.
- Connect the chimney fan to terminals 4–6.
- Adjust the value in menu 31 to 1 (PDS connected).

NB: If $\frac{\text{PDS}}{\text{AUX}}$ is flashing, the EBC22 is preparing for a PDS-check.

User Menu



ATTENTION! Remember to set up the operating function of the EBC22 as described on page 22

Layout of the user menu

The user menu provides access to 5 functions:

Menu	Function	Range
1	Setting of the chimney fan output for stage 1 (LOW)	35-100%
2	Setting of the chimney fan output for stage 2 (HIGH)	35-100%
3	Setting the pre-purge period for the chimney fan	0-999 s
4	Setting the post-purge period for the chimney fan	0-60 min
5	Displaying current alarm (see alarm overview page 42)	-

When the instructions refer to the menu numbers 1, 2, 3, 4 and 5 it is understood that these numbers refer to the user menus.

Operating the user menu

Setting up the operating function

Before you can use the EBC22 as a 2-stage speed regulator for Exodraft chimney fans, you must change the operating function.

The procedure for setting up the operating function is described on page 22

Step	Press...	To...
1		Activate the user menu
2	and	Go to the menu item you wish to edit
3		Edit the menu item selected
4	and	Adjust the required set point
5		Confirm the required set point
6		To save the required set point: Press again within 5 seconds
7		Return to operation screen. NB: If you do not press the EBC22 will automatically return to the operation screen after 30 seconds

You can always undo an action (that you have not confirmed by pressing) and return to the operation screen by pressing

Adjust the set points for user menu items 1–4 as shown in the example on the following page.



ATTENTION! If you do not press any buttons for 30 seconds, the EBC22 will automatically switch back to the operation screen.

Alarms

For alarm handling (menu 5), see page 41-42

Set-up

Setting the chimney fan output







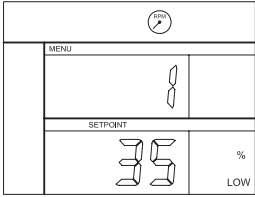
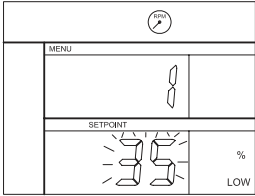
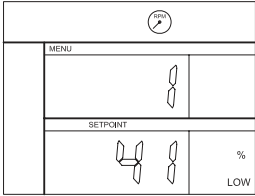
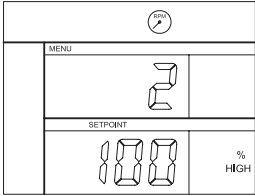
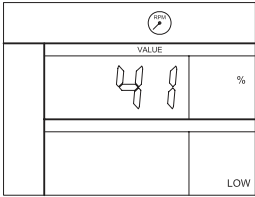

Commissioning should be carried out by staff with the appropriate training, and with the authorisation to do so according to local legislation.

Use the following procedure to adjust the chimney fan output:

Step	Action...	The display shows...
1	Press OK to go to menu 1. The output for stage 1 (LOW) will be displayed.	
2	Press OK	
3	<ul style="list-style-type: none"> Press ← and → until the output you require for stage 1 (LOW) (in this example 41%) is displayed. Press OK to confirm the set point Within 5 seconds, press OK again, to save the set point 	
4	<p>Only for 2-stage systems:</p> <ul style="list-style-type: none"> Press → to go to menu 2 and the settings for stage 2 (HIGH). 	
5	<ul style="list-style-type: none"> Repeat steps 2–3 of the procedure, only this time use them to regulate stage 2. To finish, press RESET. 	

Commissioning

Commissioning must be carried out on the EBC22 to ensure a correct draft from the system. Do as follows:

Step	Action...
1	Setting chimney fan stage 1 (LOW) <ul style="list-style-type: none"> • Press  to go to Menu 1. • Press . • Press  or  to set the "LOW" value to max (100%). • Press  to confirm the set point. • To save the set point: Press  again within 5 seconds. • Press  to return to the operation screen.
2	Start the system on stage 1.
3	Wait until the PDS is connected (PDS diode lights green).
4	<ul style="list-style-type: none"> • Access menu 1 as described in step 1. • Slowly adjust "LOW" to the correct draft. • If the PDS shows an error (the alarm diode and ^{PDS}AUX flashes), adjust the setting of the PDS.
5	Only for 2-stage systems: <ul style="list-style-type: none"> • Start the system on stage 2. • Access menu 2 and slowly adjust "HIGH" to the correct draft. • Both boiler thermostats 1 and 2 must be connected (the BOILER 1 IN and BOILER 2 IN diodes light green).
6	Check that the monitoring system shuts down the boiler. If necessary, you can simulate an error condition by disconnecting the hose from the negative terminal on the PDS.
7	After completing the commissioning, check the start-up function.

Refer to the boiler manufacturer's technical data for relevant pressure requirements and adjust the %-values accordingly.

However the following value can be considered typical:

Boilers with atmospheric burners: typically 5–10 Pa

Pressure-controlled regulation of Exodraft supply air fan

Use

General

- The EBC22 can be used to control an Exodraft BESB or BESF box fan.
- The EBC22 can control a supply air fan directly or indirectly via a frequency converter.

Positioning

Fit the EBC22 and pressure transducer (XTP) in the boiler room as described on page 13

Method of operation

General function

- The control system monitors the pressure in the boiler room and disconnects the burner in the event of errors (the alarm diode on the EBC22 will turn on).
- When the pressure in the boiler room changes, the EBC22 will change the fan speed in order to meet the setpoint pressure for the boiler room.
- The EBC22 is linked to the boiler system in such a way that when a heating requirement arises, the EBC22 will start the fan and delay the start of the boiler until the pressure in the boiler room is sufficient.
- A safety function ensures that if the pressure in the boiler room is insufficient, the EBC22 will shut down the boilers.

Electrical connection

Isolation switch



ATTENTION! This work must be performed by a qualified electrical engineer, in accordance with locally applicable rules and legislation.



The installation of the supply cable must be carried out in accordance with applicable regulations and legislation.

The earth terminal (\perp) must always be connected.

When connecting pressure transducer (XTP) and frequency converter, screened cable must be used.

Sample wiring diagram



Exodraft stresses that in accordance with EU's Machinery Directive an isolation switch must be set up in the fixed installation. The isolation switch is not supplied by Exodraft. Available as an extra.



The following sample wiring diagram shows how to connect the EBC22 to a frequency converter/MPR relay. Exodraft recommends that you contact the boiler manufacturer for details of correct connection of the boiler control system.

Connection of frequency converter/MPR relay

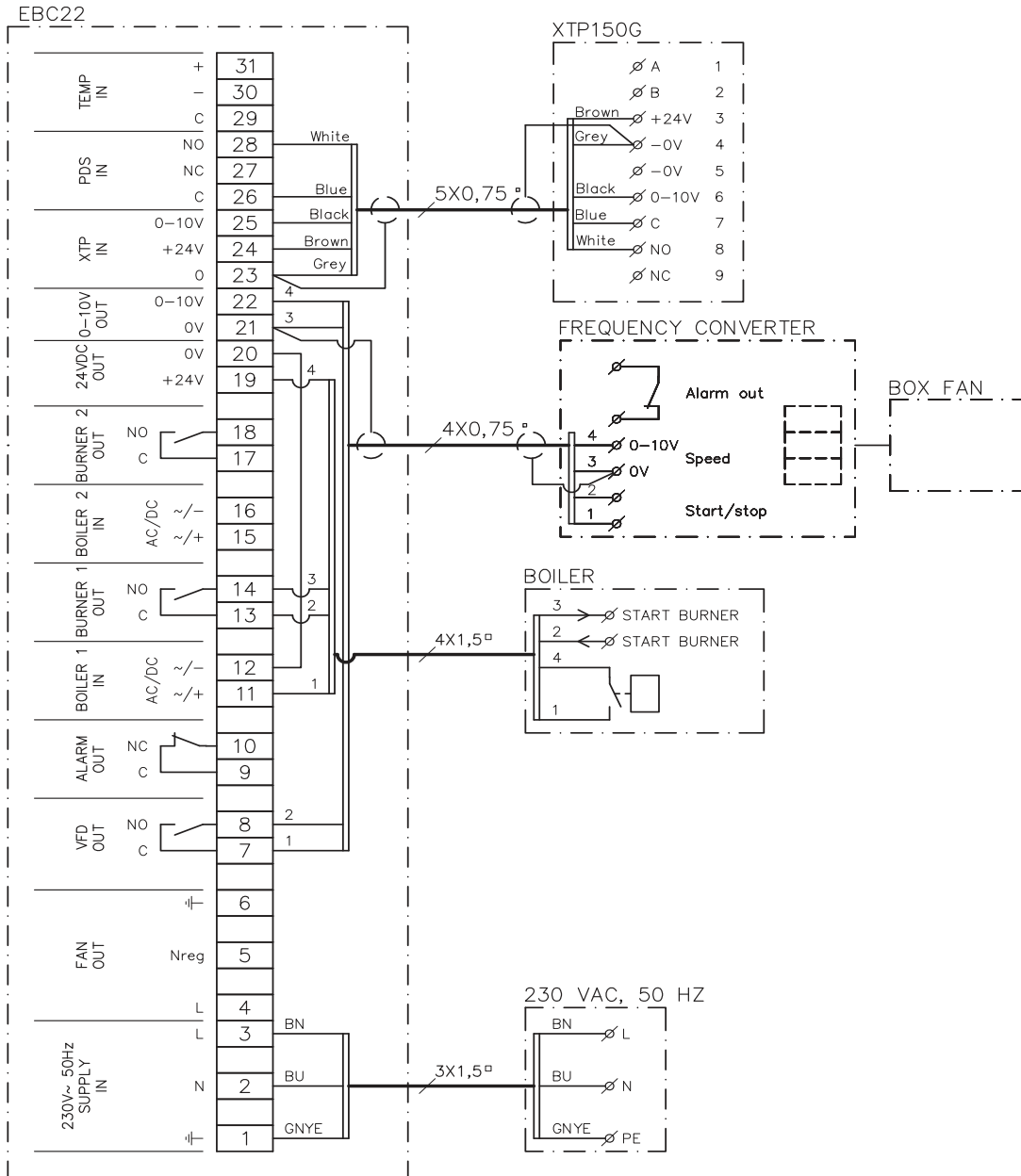

This example shows which inputs/outputs on the EBC22 need to be connected to the frequency converter/MPR relay

- Connect the supply voltage to terminals 1–3.
- Loop terminals 12 & 20.
- Connection to the boiler:
 - Connect the burner start signal to terminals 13 & 14.
 - Connect the potential free contact to terminals 11 & 19.
- Frequency converter:
 - Connect terminals 7 & 8 to the start/stop input on the frequency converter.
 - Connect terminals 21 & 22 to the frequency converter input for external speed regulation.
- Connect the pressure transducer (XTP) to terminals 23–28.

User menu

Layout of the user menu

The user menu consists of a single level and provides access to 4 parameters:

Menu	Function	Range
1	Setting the required pressure	Depending on the XTP-range set in menus 151 and 152
2	Setting the pre-purge period for the fan	0-999 s
3	Setting the post-purge period for the fan	0-60 min
4	Displaying current alarm (see alarm overview page 34)	-

When the instructions refer to the menu numbers 1, 2, 3 and 4 it is understood that these numbers refer to the user menus.

Operating the user menu

Before you can use the EBC22 for pressure controlled regulation of Exodraft supply air fans, you will have to change the operating function.



Commissioning should be carried out by staff with the appropriate training, and with the authorisation to do so according to local legislation.

For setting up the operating function, see page 22.

Using the buttons

Step	Press...	To...
1		Activate the user menu
2	and	Go to the menu item you wish to edit
3		Edit the menu item selected
4	and	Adjust the required set point
5		Confirm the required set point
6		To save the required set point: Press again within 5 seconds
7		Return to operation screen. NB: If you do not press the EBC22 will automatically return to the operation screen after 30 sec.

You can always undo an action (that you have not confirmed by pressing) and return to the operation screen by pressing

Adjust the set points for user menu items 1–4 as shown in the example on the following page.

Alarms

For alarm handling (menu 5), see page 41-42



Set-up



Some systems require a special start-up procedure following safety shut-down. Follow this procedure before pressing the  button.

Setting the pressure







To set up the EBC22, do the following:

Step	Action
1	Follow the procedure on page 22 for changing the operating function into pressure-controlled regulation of an Exodraft supply air fan, ( operating function 3).
2	Follow the procedure page 18 for setting the required pressure in the boiler room. The procedure is the same as for setting a chimney draft. The only difference is that the  symbol is shown in the display on completion of step 1. Set the pressure in accordance with locally applicable requirements.

Commissioning

Commissioning of the EBC22 must be carried out so that the supply air fan ensures correct pressure in the room.

Do as follows

Step	Action...
1	Provisional setting of the pressure in the boiler room <ul style="list-style-type: none"> • Press  to go to Menu 1. • Press . • Press  or  to adjust the value until the required pressure is shown in the display • Press  to confirm the set point. • To save the set point: Press  again within 5 seconds. • Press  to return to the operation screen.
2	Start the boiler system at max. output.
3	Check that the control system regulates to the set point.
4	Check the safety monitoring.
5	<ul style="list-style-type: none"> • If appropriate, simulate error conditions by switching off the supply air fan. • Burner is switched off (diode switches off) and the alarm diode illuminates.
6	After completing the commissioning, check the start-up function by restarting the system.

For the set point values, please refer to the data for the boiler in question. However, ± 5 Pa can be considered typical.

List of alarms and troubleshooting

Alarm handling

There are two levels of alarm handling:

- Resetting a current alarm (user menu)
- Resetting the alarm log (service menu)

Resetting a current alarm



An alarm situation in the system is indicated by the illumination of the EBC22 alarm diode (see page 15), and by the appearance of the alarm symbol  in the display.

Automatic reset

If menu 25 is set to automatic reset (1), the EBC22 will attempt to reset an alarm every 10 seconds. If error persists, check the alarm overview (next page) for solution.

Manual reset

If menu 25 is set to manual reset (2), alarms must be manually reset. In the event of an alarm, undertake the following procedure:

Step	Action...
1	Go to menu 4 (menu 5 for operating function 2, ) to display the current alarm.
2	Check the alarm overview (next page) to identify the alarm number.
3	Solve the error.
4	<ul style="list-style-type: none"> • Press  to reset the alarm* • The alarm diode will switch off, and the alarm symbol  will disappear from the display.
5	Restart the system if necessary.
6	After completing the commissioning, check the start-up function by restarting the system.

* The EBC22 will automatically return to the main screen if no buttons are pressed for 30 seconds. If this happens, repeat step 1.

Resetting the alarm log

The alarm log (menus 211–219) is a list of the 9 most recent alarms. To reset the alarm log, do the following:

Step	Action...
1	Go to menu 22 and select YES.
2	A 10-second countdown will start. Within these 10 seconds, you can cancel your choice by pressing any button. If you do not press any buttons, the alarm log will be reset.
3	Press  to return to the main screen

Alarm overview

The table below presents an overview of the alarms that may occur (the alarm numbers are displayed in the alarm menu).

Alarm	Error type	Solution
A00	No error	
A01	XTP flow alarm Defaults (menu 23):Chimney fan: < 64% of set pressure Air supply fan: > 300% of set pressure	Check: The flue, the chimney and the chimney fan for blockages. The commissioning. That the measuring probe and the spigots on the pressure transducer are not blocked.
A02	PDS check error	Check: The setting of the monitoring unit (the PDS). The connection to the PDS. The PDS's switch function.
A03	PDS error (flow error)	Check that: The PDS is connected. The PDS is correctly adjusted in relation to the set point. Menu 31 has been set correctly (1).
A04	XTP Start Timer error (flow error)	Check: the hose to the pressure transducer. the commissioning. the chimney fan is of sufficient capacity.
A10	XTP not connected	
A11	PDS not connected	Check the PDS connection.
A13	AUX alarm (alarm for terminals 26–28)	Check: the connections to terminals 26–28. the setting in menu 31 (2). the loop between terminals 26 and 28. If XTP150 connected : power off/on the unit. If error persist contact dealer (defective unit).
A14	Temperature sensor not connected	Check: that the temperature sensor is connected. If the connection is good, then the temperature sensor may be faulty. Change the sensor
A15	Temperature alarm	Inspect unit
A16	24 VDC overloaded	Check the load on terminals 19-20. If error persists, contact dealer (defective unit).
A17	XTP connected (error only for the 2-stage speed regulation function)	Remove the XTP. The XTP must not be fitted in speed-regulation mode.
A18	XTP overload	Check if XTP is defective.
A81	E2prom read failure	
A82	Error in Safety relay circuit	
A83	Error in Safety relay circuit	
A84	Error in Safety relay circuit	Reset to defaults (menu 18). Turn the EBC22 off.
A85	Safety No HeartBeat	Restart again.
A86	Safety input circuit error	If error persists, contact dealer (defective unit).
A87	Safety input circuit error	
A88	Safety input circuit error	
A89	Faulty heartbeat from safe processor detected	
A91	Temperature sensor not connected	Check that the temperature sensor is connected. If the connection is good, then the temperature sensor may be faulty. Change the sensor
A92	Temperature alarm	Inspect unit
A98	Faulty main processor	Reset to defaults (menu 18). Turn the EBC22 off.
A99	Faulty main processor	Restart again. If error persists, contact dealer (defective unit).

More troubleshooting

Program running

If there is doubt about whether the EBC22 is running: Check if the control LEDs are flashing.

To view the control LEDs: Remove the front panel.



This work must be performed by a qualified electrical engineer.

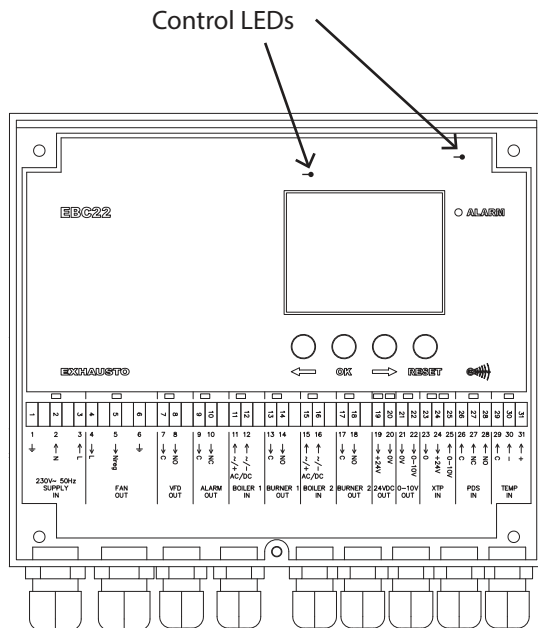

Communication error

If the display shows three horizontal lines in the lowest display box:

Press **RESET** and repeat the setting

If the error persists, then the EBC22 is faulty. Contact dealer.

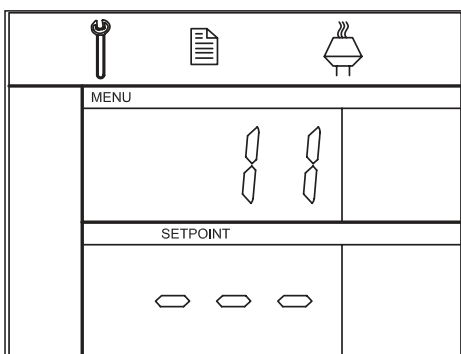



UK Conformity Assessed



**Exodraft a/s
Industrivej 10
DK-5550 Langeskov**

Hereby declares that the following products:

EBC22EU01, EBC22EU02

Were manufactured in conformity with the provisions of the following regulations:

The Supply of Machinery (Safety) Regulations 2008

Electrical Equipment (Safety) Regulations 2016

Electromagnetic Compatibility Regulations 2016

Langeskov, 01-11-2022
Managing Director
Anders Haugaard



Declaration of Conformity

DK: EU-Overensstemmelseserklæring
 GB: Declaration of Conformity
 DE: EU-Konformitätserklärung
 FR: Déclaration de conformité de l'Union Européenne
 NO: EU-Samsvarserklæring
 PL: EU Deklaracja zgodności

NL: EU-Conformiteits verklaring
 SE: EU-Överensstämmelsedeklaration
 FI: EU-Vaatimustenmukaisuusvakuutus
 IS: ESS-Samræmisstaðfesting
 IT: Dichiarazione di Conformità Unione Europea



Exodraft a/s
Industrivej 10
DK-5550 Langeskov

Erklærer på eget ansvar, at følgende produkter:
 Hereby declares that the following products:
 Erklärt hierdurch auf eigene Verantwortung, daß folgende Produkte:
 Déclare, sous sa propre responsabilité, que les produits suivants:
 Erklærer på eget ansvar at følgende produkter:
 Niniejszym oświadczam, że następujące produkty:

Veklaart dat onderstaande producten:
 Deklarerar på eget ansvar, att följande produkter:
 Vastaa siltä, että seuraava tuote:
 Staðfesti à eigin àbyrgð, að eftirfarandi vörur:
 Dichiaro con la presente che i seguenti prodotti:

EBC22EU01, EBC22EU02

Som er omfattet af denne erklæring, er i overensstemmelse med følgende standarder:
 Were manufactured in conformity with the provisions of the following standards:
 Die von dieser Erklärung umfaßt sind, den folgenden Normen:
 Auxquels s'applique cette déclaration sont en conformité avec les normes ci-contre:
 Som er omfattet av denne erklæring, er i samsvar med følgende standarder:
 Zostały wyprodukowane zgodnie z warunkami określonymi w następujących normach:

Zijn vervaardigd in overeenstemming met de voorschriften uit de hieronder genoemde normen en standaards:
 Som omfattas av denna deklaration, överensstämmer med följande standarder:
 Jota tämä selvitys koskee, on seuraavien standardien mukainen:
 Sem eru meðtalin í staðfestingu Pessari, eru í fullu samræmi við eftirtalda staðla:
 Sono stati fabbricati in conformità con le norme degli standard seguenti:

EN 60335-1, EN 60335-2-80, DS/EN ISO 12100: 2011

I.h.t bestemmelser i direktiv:
 In accordance with
 Entsprechen gemäß den Bestimmungen der folgenden Richtlinien:
 Suivant les dispositions prévues aux directives:
 I.h.t bestemmelser i direktiv:
 Zgodnie z:

En voldoen aan de volgende richtlijnen:
 Enligt bestämmelserna i följande direktiv:
 Seuraavien direktiivien määräysten mukaan:
 Med tilvisun til ákvarðana eftirlits:
 In conformità con le direttive:

Maskindirektivet:
 The Machinery Directive:
 Richtlinie Maschinen:
 Directive Machines:
 Maskindirektivet:
 Dyrektywę maszynową:

De machinerichtlijn:
 Maskindirektivet
 Konedirektiivi:
 Vælaeftirlitið:
 Direttiva Macchinari:

2006/42/EF-EEC/-EWG/-CEE

Lavspændingsdirektiv:
 The Low Voltage Directive:
 Niederspannungsrichtlinie:
 Directive Basse Tension:
 Lavspenningsdirektivet:
 Dyrektywę Niskonapięciową

De laagspanningsrichtlijn:
 Lågspänningsdirektivet:
 Pienjännitedirektiivi:
 Smáspennueftirlitið:
 Direttiva Basso Voltaggio:

2014/35/EC

EMC-direktivet:
 And the EMC Directive:
 EMV-Richtlinie:
 Directive Compatibilité Electromagnétique:
 EMC-direktivet:
 Dyrektywę EMC – kompatybilności elektromagnetycznej

En de EMC richtlijn:
 EMC-direktivet:
 EMC-direktiivi:
 EMC-efirlitið:
 Direttiva Compatibilità Elettromagnetica:

2014/30/EC

Langeskov, 01-11-2022
 Adm. direktør
 Managing Director
 Anders Haugaard

Algemeen directeur
 Geschäftsführender Direktor
 Président Directeur Général
 Verkställande direktör
 Toimitusjohtaja
 Framkvemdastjóri
 Direttore Generale

DK: Exodraft a/s

Industrivej 10
DK-5550 Langeskov
Tel: +45 7010 2234
Fax: +45 7010 2235
info@exodraft.dk
www.exodraft.dk

SE: Exodraft a/s

Kalendevägen 2
SE-302 39 Halmstad
Tel: +46 (0)8-5000 1520
info@exodraft.se
www.exodraft.se

NO: Exodraft a/s

Storgaten 88
NO-3060 Svelvik
Tel: +47 3329 7062
info@exodraft.no
www.exodraft.no

UK: Exodraft Ltd.

24 Janes Meadow, Tarleton
GB-Preston PR4 6ND
Tel: +44 (0)1494 465 166
Fax: +44 (0)1494 465 163
info@exodraft.co.uk
www.exodraft.co.uk

DE: Exodraft a/s

Niederlassung Deutschland
Soonwaldstr. 6
DE-55569 Monzingen
Tel: +49 (0)6751 855 599-0
Fax: +49 (0)6751 855 599-9
info@exodraft.de
www.exodraft.de

FR: Exodraft sas

78, rue Paul Jozon
FR-77300 Fontainebleau
Tel: +33 (0)6 3852 3860
info@exodraft.fr
www.exodraft.fr

Your energy. Optimized.

The logo for Exodraft, featuring the word "exodraft" in a bold, lowercase sans-serif font. The letter "x" is stylized with a curved line that loops around the top and right sides of the letter, suggesting motion or energy.